

***EcoPower Xpress* 160 – 500 t**

The high-speed machine

world of innovation



DYNAMIC – ACCURATE – HIGHLY EFFICIENT

For thin-walled parts in large volume

The advantages

- » Servo-electric high-performance injection molding system for thin-walled products
- » With injection units in 3 sizes for injection speeds of up to 600 mm/s and injection pressures of up to 2500 bar
- » Highly dynamic injection acceleration of up to 15000 mm/s²
- » High-performance plasticizing with 22:1 L/D or 26:1 L/D (Option) barrier screws
- » Maintenance-free 5-point toggle lever system with encapsulated central lubrication system and lubricant storage inside the toggle lever bolts
- » Ultimate level of production safety through fast-responding mold protection system
- » Maximum cycle efficiency with comprehensive parallel functions
- » Energy-efficient through deceleration energy recovery via patented KERS system
- » User-friendly thanks to new UNILOG B8 control system with integrated assistance systems
- » “Plug and Produce” extension options to create a complete production cell with WITTMANN auxiliary equipment and the WITTMANN 4.0 integration package

The series

- » *EcoPower Xpress*: currently 5 sizes – 160 to 500 t clamping force



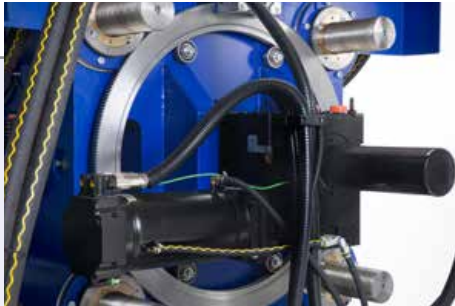

Photo: Plasticsud SAS

EcoPower Xpress

The system highlights

- » **High-performance electric drives for all main movements**
EcoPower Xpress machines are high-performance machinery for extremely short cycle times, whose main movements (closing/opening, screw rotation, screw infeed) are driven by water-cooled servo motors. The mold height adjustment system of the clamping unit is also driven by a servoelectric motor. A hydraulic system with servo drive is used for the secondary movements (ejector, nozzle stroke/nozzle contact, core pulls).
- » **Powerful, highly dynamic injection units**
 The injection movement and retraction of the screw during plasticizing are driven by twin herringbone gear racks with symmetrical force transmission. The pressure on the screw is measured directly behind the coupling. The drive shaft for screw rotation (plasticizing) is guided centrally through the gear rack housing and combined with a reduction gear system.
- » **Fast toggle lever clamping system**
 The clamping unit is a 3-platen/4-tie-bar system with a 5-point toggle lever, self-locking in the end position, with a drive system consisting of a servo motor and rack-and-pinion gears. The highly rigid moving platen travels on a moving carriage on the machine frame, supported by linear guides and rotating roller bearings, without contact to the tie-bars. The moving carriage offers high load-bearing capacity reserves for operating heavy molds without compromising on precision.
- » **KERS – energy recovery is standard**
 The KERS kinetic energy recovery system is patented for injection molding machines. It converts kinetic energy released in deceleration processes into electric energy, which is then used within the machine. This leads to a reduction of power consumption.
- » **Mould Protect – fast-response mold protection**
 The linear guides of the clamping unit (moving platen and crosshead), which are virtually free of friction, and a fast-response measurement of power input fluctuations in the drive motor provide the prerequisites for a highly sensitive mold protection system.

CLAMPING UNIT

Fast – sensitive – powerful

» Ample space for multi-cavity molds

- Generously dimensioned mold platens and a 5-point toggle lever clamping system with symmetrical force transmission ensure optimal conditions for molds with high numbers of cavities, including media supply connections. [1]
- Easy access to the ejector and platen environment for cleaning [2]
- The machine frame is designed for a disposal chute height of 500 mm in three directions, to the front, to the rear and along the longitudinal axis. It thus offers ample space for transverse and longitudinal conveyor belts. [3]

» Sensitive and accurate

In the *EcoPower Xpress* clamping system, the tie-bars handle exclusively the force transmission between the external platens. A generously dimensioned moving carriage takes care of guiding the moving platen on the machine frame. [4] Both the moving carriage and the crosshead of the toggle lever [5] are guided on virtually friction-free linear bearings.

» Maintenance-free, clean room-compatible toggle lever system

- The five-point toggle lever with optimized kinematic design is self-locking in the fully extended end position.
- The toggle pins are clamped free of play inside the platens and levers.
- The mold height adjustment device with 4 bronze tie-bar nuts and a sun gear is driven by a servo motor.
- The central lubrication system of the toggle lever joints is completely encapsulated and maintenance-free. The lubricant is metered via monitored progressive flow dividers. Used lubricant is stored in a reservoir system inside the toggle lever bolts. This extends the service intervals to several years and minimizes potential emissions.

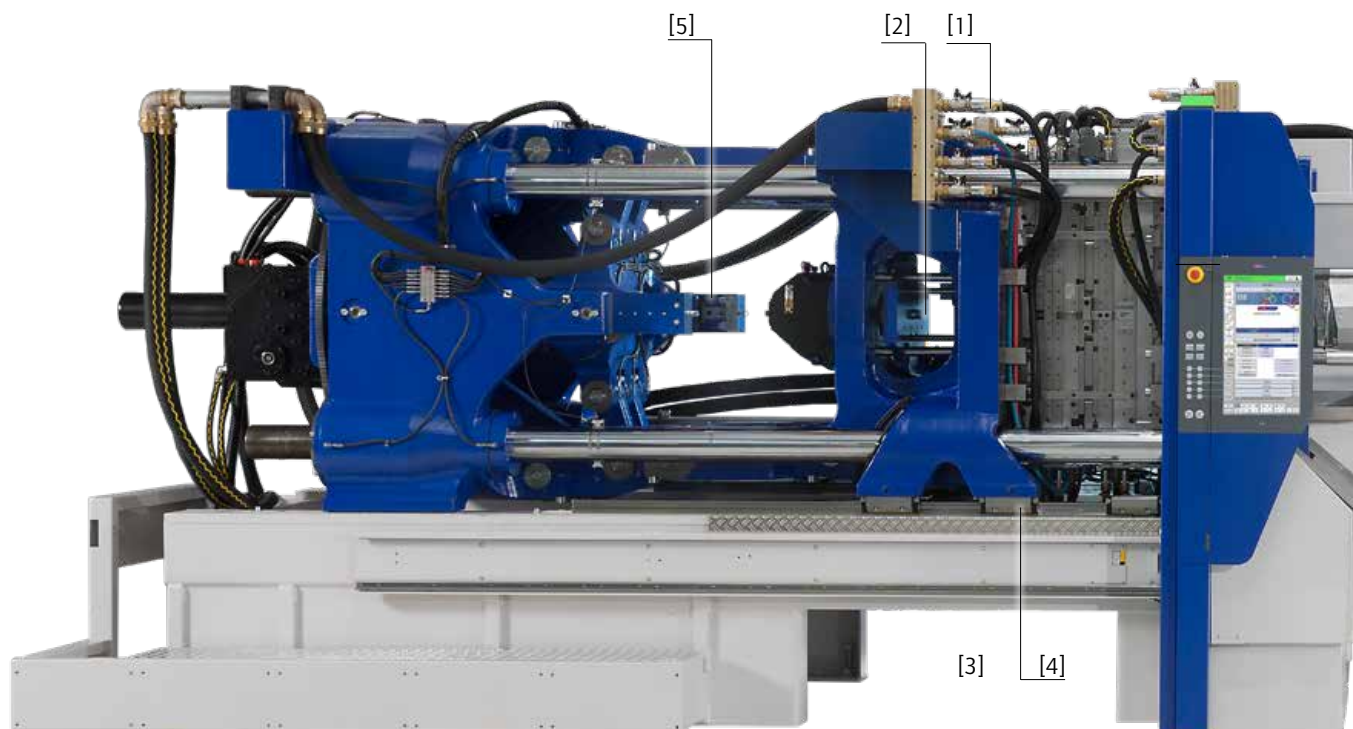

INJECTION UNIT

No compromise on speed

Wittmann

Battenfeld

» **All prerequisites for fast mass production in place**

- Electrical high-speed injection unit with injection speed of up to 600 mm/s, acceleration/ deceleration of up to 15000 mm/s² and injection pressures of up to 2500 bar
- Injection drive via twin herringbone gear racks [6] and two water-cooled servo motors [7], with encapsulated and consequently maintenance-free lubrication system
- Metering drive with offset-g geared, water-cooled servo motor [8]
- Stroke measurement system with digital absolute encoder
- Moment-free nozzle contact through parallel positioning of pressure cylinders [9]
- For easy barrel change, every all-electric injection unit is designed with a large retraction stroke to allow barrel change from the top with a crane.
- In combination with the (optional) WITTMANN BATTENFELD HiQ software modules, highly sensitive control mechanisms are available to compensate external influencing factors such as temperature and moisture, regrind or masterbatch content.



L/D 26:1 barrier screw as option

Since barrier screws enable an essentially higher plasticizing throughput for PE and PP compared to standard three-zone screws of the same diameter, they are included in the standard equipment package with L/D 22:1 for *EcoPower Xpress* machines. Special screws adapted for materials other than PE and PP are available as an option.

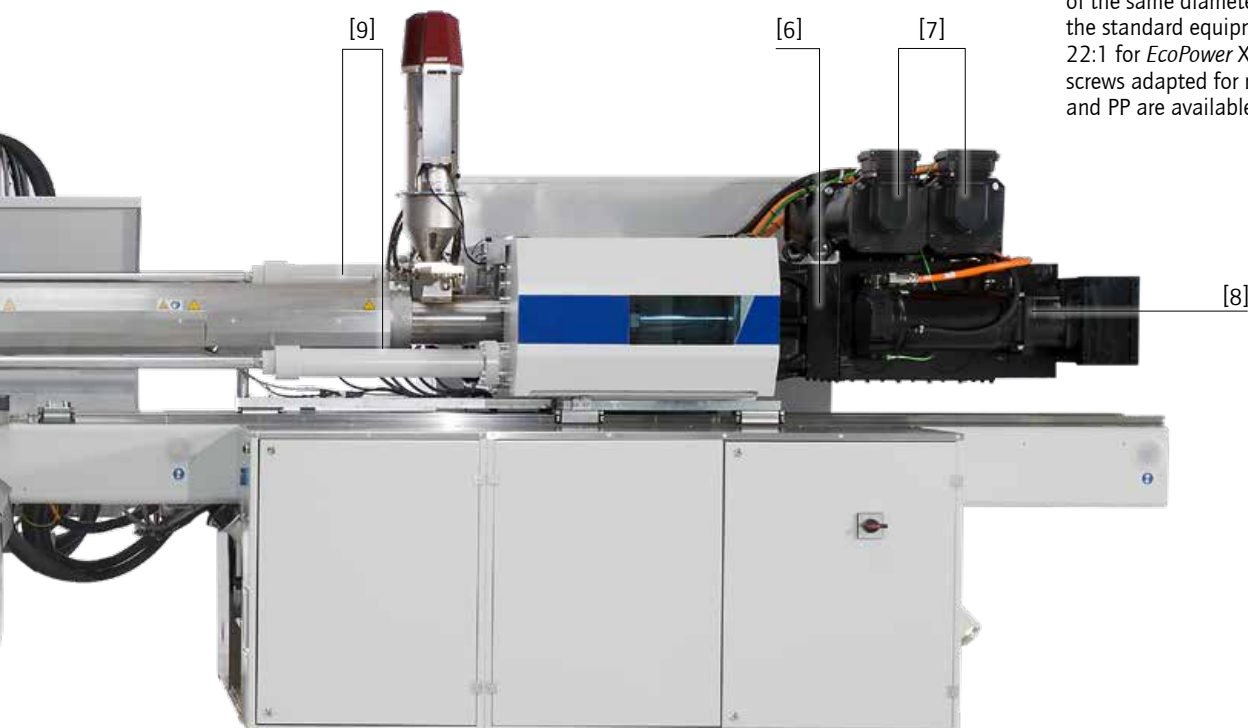

DRIVE TECHNOLOGY

Combining high performance with efficiency



Dynamic, accurate, efficient

- » Powerful, water-cooled servo motors combined with rack-and-pinion gears to drive the toggle lever clamping unit and the injection unit. The plasticizing motor is combined with a gear transmission system.
- » Secondary movements (ejector, nozzle stroke and core pulls as standard) are powered by a hydraulic aggregate with a fully encapsulated servo-electric drive. Thanks to its high-efficiency design, no cooling water connection is required.
- » The decentralized drive concept and the functions provided by the UNILOG B8 machine control system offer all options for simultaneous operation of drive functions, such as plasticizing and clamping force build-up parallel to injection, or the ejector movement simultaneously with clamp opening motion.
- » Ultimate precision of movements is ensured by the combination of servo drives with digital absolute encoders.
- » All motor/drive system combinations are fully encapsulated to prevent lubricant emissions, and consequently clean room compatible.
- » Low sound emission level (< 67 dBA) through water cooling of the servo motors and positioning of the servo-hydraulic system inside a sound-insulated pump chamber.



OPTIONS

Flexible and highly efficient

Wittmann

Battenfeld

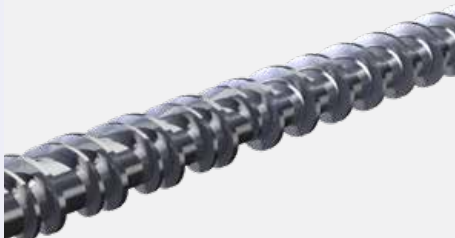

EcoPower Xpress

The option highlights

- » **4-tie-bar strain measurement and monitoring**
To prevent a potential asymmetric overload of the clamping unit in continuous operation through pressure peaks caused by high-speed injection, a 4-tie-bar strain measurement device together with the corresponding monitoring software is available as an option.
- » **Servo-electric ejector**
As an alternative to the servo-hydraulic drive for the ejector included as standard, a faster-response version with a servo motor combined with an encapsulated rack-and-pinion drive is available as an option.
- » **Barrier screw with mixing section and 26:1 L/D ratio**
The high-performance plasticizing unit of the *EcoPower Xpress* machine comes with a 22D barrier screw and mixing section as standard. For even better material homogeneity and plasticizing performance, it can be supplied with a 26:1 L/D ratio as an option.
- » **Heavy-duty media connections**
The cooling water system for mold cooling can be adapted to specific projects and products. The standard system consists of large-diameter main inlets and outlets. These are connected to the distributor blocks on the mold. The power connections for hot-runner heating circuits, temperature and pressure sensors and/or encoding signals can also be customized in terms of numbers and models.
- » **WITTMANN auxiliaries**
The comprehensive range of auxiliary appliances from WITTMANN offers suitable solutions for all secondary injection molding processes, including parts handling as well as material drying and loading, sprue recycling and mold cooling and tempering. Via the optional WITTMANN 4.0 integration package, all ancillary appliances can be integrated directly (without interface) into the injection molding machine's production program ("Plug & Produce").

PACKAGING SOLUTIONS with IML Technology

In this field, the WITTMANN customers are focused on the planning and implementation of complete turnkey systems for IML applications. Here, WITTMANN offers complete automation cells on the basis of top and side entry parts removal units. These systems cover a wide range of use, from rather simple ones to highly complex systems that also include the handling of lids and camera control.



Example of a top entry production cell to make packaging articles:

flexible, low-cost solution to produce paint buckets using an IML (In-Mold Labeling) process



Complete W837 IML production cell in horizontal design:

high-performance production cell with 100 % integrated camera quality inspection station and stacking unit for food containers



LIDS, CONTAINERS AND MORE

System competence

Wittmann

Battenfeld



» Ultra-light logistics container

The *EcoPower Xpress* injection units offer every possibility for producing lightweight, thin-walled stacking boxes for food items, but also have ample potential for lightweight engineering parts with high flow path/wall thickness ratios. One example are lightweight transport boxes for food items, often made of 100 % regrind.



Photo: Plastisud SAS

» Injection molding for packaging

The generously dimensioned clamping units of the *EcoPower Xpress* machines in combination with high plasticizing and injection capacities are the ideal equipment for operating high-speed, multi-cavity molds to make all types of closures, lids and containers.



» IML - In-Mold Labeling

The high-speed *EcoPower Xpress* machines combined with the proven automation technology from WITTMANN provide the basis for high-performance in-mold labeling production cells to make decorated containers in one production step.



» Disposable products

The high-performance attributes of the new *EcoPower Xpress* machines enable efficient and simultaneously resource-friendly mass production of ultra-light one-way products such as drinking cups, disposable cutlery, plates or buckets.

UNILOG B8

Complex matters simplified

The UNILOG B8 machine control system is the WITTMANN BATTENFELD solution to facilitate the operation of complex processes for human operators. For this purpose, the integrated industrial PC has been equipped with an enlarged intuitive touch screen operator terminal. The visualization screen is the interface to the new Windows® 10 IoT operating system, which offers extensive process control functions. Next to the pivotable monitor screen, a connected panel/handset is mounted on the machine's central console.



UNILOG B8

Highlights

- » **Operating logic**
with a high degree of self-explanation, similar to modern communication devices
- » **2 major operating principles**
 - Operating/movement functions via tactile keys
 - Process functions on touch screen (access via RFID, key card or key ring)
- » **Process visualization**
via 21.5" touch screen display (full HD), pivoting laterally
- » **New screen functions**
 - Uniform layout for all WITTMANN appliances
 - Recognition of gestures (wiping and zooming by finger movements)
 - Container function – split screen for sub-functions and programs
- » **Status visualization**
uniform signaling system across the entire WITTMANN Group
 - Headline on the screen with colored status bars and pop-up menus
 - ambiLED display on machine
- » **Operator assistance**
 - *QuickSetup*: process parameter setting assistant using an integrated material database and a simple query system to retrieve molded part data with machine settings pre-selection
 - Extensive help library integrated

The process in constant view



» **SmartEdit**

SmartEdit is a visual, icon-based cycle sequence programming facility, which enables direct addition of special functions (core pulls, air valves, etc.) based on a standard process via touch operation on the screen. In this way, a total user-defined sequence can be compiled from a sequence menu. This machine cycle, visualized either horizontally or vertically, can be adjusted simply and flexibly to the process requirements by finger touch with "drag & drop" movements.

The advantages

- Icon visualization ensures clarity.
- Clear events sequence through node diagram
- Alterations without consequences through "dry test runs"
- Theoretical process sequence can be quickly implemented in practice.
- Automatic calculation of the automation sequence based on the actual set-up data set without machine movements

» **SmartScreen**

- Partitioning of screen displays to visualize and operate two different functions simultaneously (e.g. machines and auxiliaries)
- Uniform design of the screen pages within the WITTMANN Group
- Max. 3 containers can be addressed simultaneously for the *SmartScreen* function.
- Adjustments of set values can be effected directly in the set value profile.

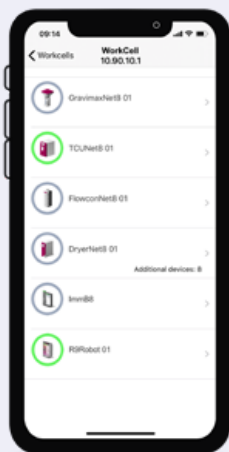
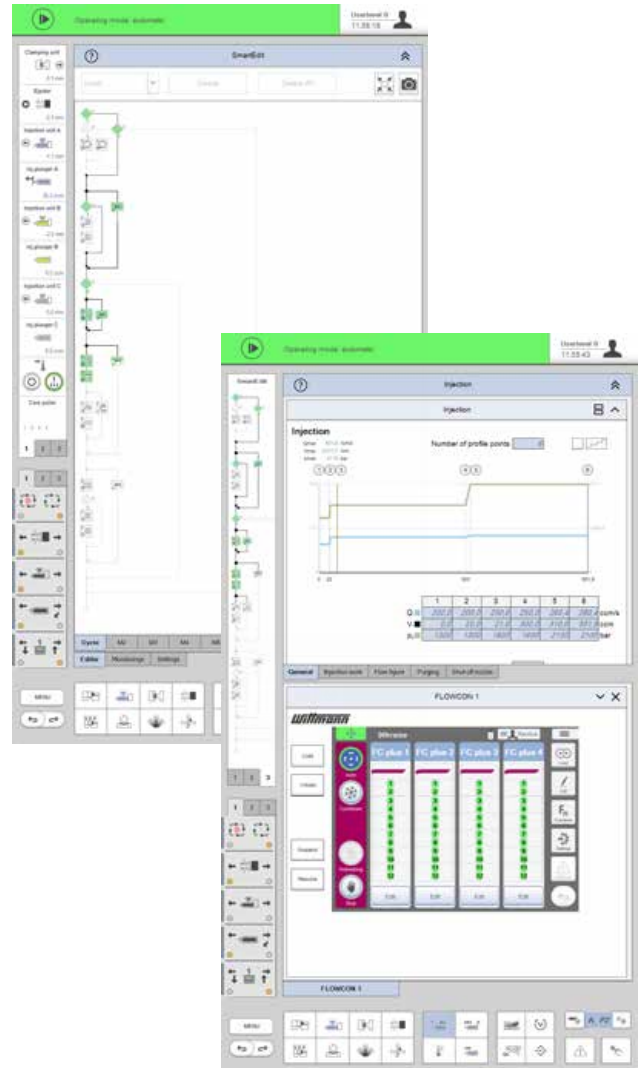

Remote communication

» **QuickLook**

- Production status check via smartphone – simple and comfortable:
- Production data and statuses of all essential appliances in a production cell
 - Complete overview of the most important production parameters
 - Access to production data, error signals and user-defined data
 - The production cell overview offers a clear, simple overview of the production cell's general condition and that of its individual WITTMANN 4.0 appliances.

» **Global online service network**

- Web-Service 24/7: direct Internet connection to WITTMANN BATTENFELD service
- Web-Training: efficient staff training by means of the virtual training center

WITTMANN 4.0

Communication in and with production cells

With its communication standard WITTMANN 4.0, the WITTMANN group offers a uniform data transfer platform between injection molding machines and auxiliary equipment from WITTMANN. In case of an appliance change, the corresponding visualizations and settings are loaded automatically via an update function, following the principle of "Plug & Produce".

Connection of auxiliaries via WITTMANN 4.0

- » **WITTMANN FLOWCON plus water flow regulator, GRAVIMAX blenders and ATON dryers**
 - Units directly addressed and controlled via the machine's control system
 - Joint saving of data in the production cell, the machine and in the network via MES
- » **WITTMANN robots with R8 control system**
 - Operation of robots via the machine's monitor screen
 - High-speed communication between machine and robot to synchronize movements
 - Important machine movements can be set via the R8 robot control system
- » **WITTMANN TEMPRO plus D temperature controllers**
 - Setting and control of temperatures via the machine's control system possible
 - All functions can be operated either on the unit or via the machine's control system

Integration in MES system

The integration of machines and complete production cells in an MES system is a prerequisite for an efficient and transparent production facility according to the Industry 4.0 concept.

Depending on customers' requirements, small and medium-sized companies as well as global players are offered a compact MES solution based on TEMI+. With the Windows® 10 IoT operating system it is also possible to have selected status information from all connected machines on the production floor shown under *Smart-Monitoring* on the display screen of every machine.

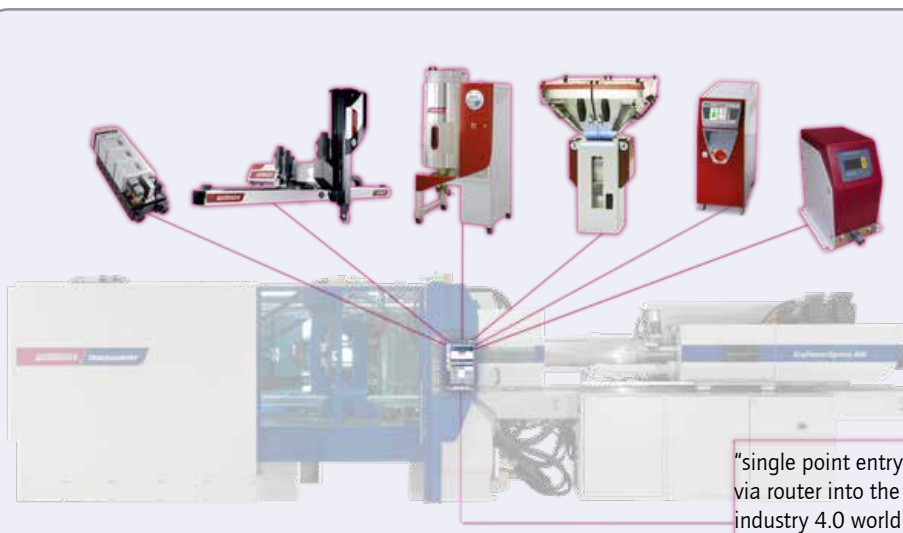

WITTMANN 4.0 system
With WITTMANN 4.0, a machine and its robots and auxiliaries are transformed into a uniform technical organism, which communicates externally via a specific IP address. Such a "single point entry" with an integrated internal firewall substantially increases cyber security.

TECHNICAL DATA

EcoPower Xpress

Wittmann

Battenfeld



COMBINATIONS

Clamping unit t	Injection unit			
	1100+	1100++	2100++	3300++
160	•	•		
210	•	•		
300	•	•	•	
400	•	•	•	•
500			•	•

Material	Factor
PE	0.71
PP	0.73
PS	0.91

The maximum shotweights (g) are calculated by multiplying the theoretical shot volume (cm³) by the above factor.

STANDARD

Base machine

Drop - voltage 400V/3p+N-TN/TT, 50 Hz

Painting RAL 7047 tele grey 4 / RAL 5002 ultramarine blue

One-piece base frame, clamping unit/injection unit with 3 disposal directions - up to 300 t

Two-piece base frame, clamping unit/injection unit with 3 disposal directions - 400 t or higher

Injection molding machine according to machinery directive 2006/42/EG incl. declaration of conformity and CE-marking

Electrical safety according to EN 60204-1

Machine safety according to EN 201

Clamping unit

Clamping system with 5-point twin toggle lever, servo electric, encapsulated, direct drive via rack-and-pinion

Clamping force and closing and opening forces adjustable

Highly sensitive mold safety program

Moving platen supported by positioned linear guides to support closing platen and crosshead

Mold platen according to EUROMAP 2, clamping surface metallic bright, rest painted

Fixing holes for robot on fixed platen as per EUROMAP 18

Servo-hydraulic multi stroke ejector

Electric mold height adjustment

Injection unit

Injection axis via servo-electric, encapsulated direct drive via rack-and-pinion and with defined servohydraulic nozzle contact pressure

Screw drive by A.C. servo motor for parallel recovery during cycle

Xaloy MeltPro™ barrier screw, L/D 22 with quick acting check valve, wear resistant screw and barrel AK+, heater bands up to 350 °C without insulation

Thermocouple failure monitor

Maximum temperature supervision

Plug-in ceramic heater bands

Temperature control of feed throat integrated

Screw and barrel change from top

Linear guides in standard design, position sensor with non-contact stroke transducer

Lowering of barrel heating

Decompression before and/or after metering

Physical units - bar, ccm, mm/s etc.

Screw protection

Auxiliary screw speed indication

Linear interpolation of holding pressure set values

Bar chart for barrel temperature with set value and actual value display

Selectable injection pressure limitation

Changeover from injection to holding pressure depending on stroke, time and pressure

Open nozzle R35

Material hopper 30 litres for automatic material feed, sliding device with shut-off function for material with sliding guide

Safety gate

Safety gate in standard execution, acrylic glass light-blue 309 / frame RAL 5002 ultramarine blue

Safety gate at operator and non-operator side manually operated

Safety gate clamping side front and back with maintenance-free locking

Electrics

Switch cabinet integrated in front and rear, IP54

ambiLED status light

Fuse protection for sockets

Emergency stop switch button in control panel

Printer socket

USB - 1 x operating unit

1 Ethernet interface (switch cabinet)

Printer via USB connection or network

Control cabinet cooler

Control system

Control system UNILOG B8 - 21,5" multi-touch screen (full HD)

Control panel with selectable haptic keys

Software for operating hours counter

Closing/Opening - 5 profile steps

Ejection forward/back - 3 profile steps

Nozzle forward/back - 3 profile steps

Injection/Holding pressure - 10 profile steps

Screw speed/Back pressure - 6 profile steps

Parts counter with good/bad part evaluation

Purging program through open mold

Stroke zero offset settings

Start-up program

Switch over to holding pressure MASTER/SLAVE by injection time, screw stroke/injection volume and injection pressure

Self-teaching temperature controller

Display of temperature inside electrical cabinet

Seven-day timer

Access authorization via USB interface, password system and RFID authorization system (1 x check card IT-level-15, 1 x token customer level-30 and 1 x token customer service level-20 are included in delivery)

Freely configurable status bar

Physical, process-related units

Automatic dimming

Logbook with filter function

User programming system (APS) for individual programming

User page

Note pad function

Cycle time analysis

Hardcopy function

Internal data storage via USB connection or network

Online language selection

Online selection of imperial or metric units

Time monitoring

BASIC Quality Monitoring (1 freely config. network connection, quality table 1000 storage depth, events protocol (logbook) for 1000 events, actual value graphics with 5 curves, 1 envelope curves monitoring)

BASIC StepForce - Injection parallel to clamping force build-up

Injection integral supervision

Metering integral supervision

Alarm message via e-mail

SmartEdit - sequence editor

QuickSetup - assistance program for initial parameter setting

Base machine

Non-standard mold height
Handling package with open machine safety gate on non operator side
Parts chute
Parts chute for separation of good/bad parts or photoelectric ejection check

Hydraulics/Pneumatics

Hydraulic core pull for clamping plate, interface according to EUROMAP 13, incl. or without core pull pressure release
Pneum. core pull on clamping plate/nozzle plate, incl. pressure regulator
Manifolds for one mold shut-off nozzle or more
Air valves on nozzle plate/clamping plate
Compressed air pressure maintenance unit incl. 1 or more way pressure regulation incl. directional exhaust valve with blocking function

Clamping unit

Mold platen according to SPI, JIS, T-slots
4-fold tie-bar expansion measurement with monitoring
Mold platen incl. cooling channels
Mold platen chemically nickel-plated
Hydraulic ejector in reinforced execution
Hydraulic ejector with boost execution
Double check valve to keep ejector in end-position
Servo-electric ejector
Ejector cross according to EUROMAP/SPI
Mechanical ejector coupling
Ejector platen safety
Mechanical mold safety mechanism

Injection unit

Xaloy MeltPro™ barrier screw, L/D 26 with quick acting check valve, wear resistant screw and barrel AK+, heater bands up to 350 °C without insulation
Non standard screws for special materials
Ball type screw tip
Melt pressure transducer, melt temperature sensor
Barrel insulation
Open nozzles in special execution
Shut-off nozzle operated pneumatically
Barrel covering and splash guard in special execution
Material hopper in special execution
Hopper magnet

Safety gate

Safety gate clamping side, rear side and/or operator side elevated, lowered or extended
Safety gate clamping side electrically operated

Cooling

Cooling water distributor with/without blow-off valve
Solenoid valve for cooling water distributor
Cooling water manifolds nozzle platen / clamping platen
Filter back flushable/water pressure supervision in inlet pipe

Electrics

Temperature control zone for hot runner
Special voltage
Additional sockets
Emergency stop button on rear side
Signal tower with acoustic element
Interface for robots as per EUROMAP 67
Interface robot, conveyor, dosing unit, temperature control unit, serial, E66-2
Interface dosing pump for Movacolor via OPC-UA / Ethernet RJ45
R/G eDart interface
Master interface for danger zone boundary (EUROMAP 78)
Interface for full integration of robot incl. Ethernet switch
Host computer interface/PDA (EUROMAP 63/77/83)
Machine fault (potential-free contact)
APP Monitoring - Monitoring function of cylinder and mold heating / TCU / FLOWCON / DRYMAX
VNC/Web browser plugin - display of an auxiliary unit in the machine control system

Control system

Energy consumption analysis
Switch over to holding pressure by cavity pressure
Switch over to holding pressure by external signal
Second injection data setting during automatic start up
User specific programmable set value limits
HiQ Cushion® - melt cushion control
HiQ Flow® - injection integral control
HiQ Melt - monitoring of material quality
HiQ Metering - active closing of the check valve
EXPERT Quality Monitoring (4 freely configurable network connections, quality table with 10000 storage depth, events protocol (logbook) for 10000 events, actual value graphic with 16 curves, 4 envelope curves monitoring, SPC charts, trend diagrams)
Additional output card/input card, freely programmable
User-specific user level system
Integration package WITTMANN 4.0

Additional equipment

Plinth for robot
Tool kit
Levelling pads
Lighting in mold space
Integration package (robot, feeder, dosing unit, TCU, mold integration)
Web service
Remote control package



WITTMANN BATTENFELD GmbH

Wiener Neustädter Strasse 81

2542 Kottlingbrunn | Austria

Tel.: +43 2252 404-0

info@wittmann-group.com

www.wittmann-group.com